

NEW

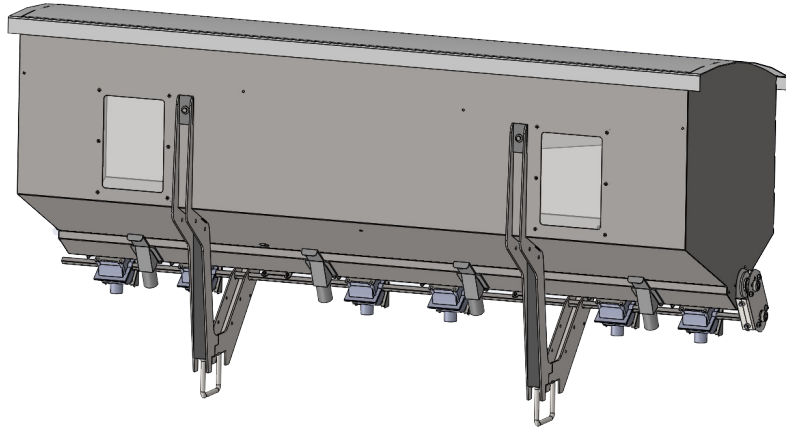

FERTILINE

Fertilizer



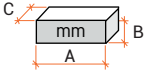

Fertilizer spreader for the distribution of granular products, with volumetric metering unit with mechanical drive and stainless-steel tank. The distribution amount may be adjusted by the metering unit partition or by modifying, electronically or hydraulically the metering unit rounds per minute.

FERTILINE - WITHOUT ADJUSTMENT

CODE	 n°	 kg	 L			
				A	B	C
11100704	4	103	700	1503	775	950
11100706	6	105	700	1503	775	950
11101004	4	131	1000	2203	775	950
11101006	6	133	1000	2203	775	950
11101008	8	135	1000	2203	775	950
11101406	6	169	1400	2883	775	950
11101408	8	198	1400	2883	775	950
11101412	12	200	1400	2883	775	950

FERTILINE - WITH ADJUSTMENT

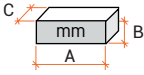
CODE	 n°	 kg	 L			
				A	B	C
11200704	4	108	700	1503	775	950
11200706	6	110	700	1503	775	950
11201004	4	136	1000	2203	775	950
11201006	6	139	1000	2203	775	950
11201008	8	140	1000	2203	775	950
11201406	6	201	1400	2883	775	950
11201408	8	203	1400	2883	775	950
11201412	12	205	1400	2883	775	950

STANDARD EQUIPMENT

Volumetric metering units

Sieve nets

Stainless-steel tank

Canvas cover

Assembling brackets for 120x120 mm toolbar

One product agitator for each exit